

# OVERVIEW OF ECO-MOORING FACILITIES

## COMMENTED SELECTED BIBLIOGRAPHY

FUNDED WITH THE SUPPORT OF THE GOVERNMENT OF SWEDEN  
IN PARTNERSHIP WITH THE FRB

AUTHORS:  
PIOCH S., LÉOCADIE A., 2017



# / INDEX

<b>1/ HISTORICAL</b>	<b>3</b>
<b>2/ ANCHORING ISSUES</b>	<b>4</b>
2.1/ Impact of anchoring	4
2.2/ Impact of conventional mooring	4
<b>3/ THREE GENERATIONS OF ECO-MOORINGS</b>	<b>5</b>
3.1/ First generation: pre-tensed anchor line mooring systems	5
- Concrete block mooring	5
- Eco-mooring using artificial reef as anchor block	5
3.2/ Second generation: screw and fixed anchor line	6
- Cyclone	6
- Helical mooring	6
- Fixed eco-mooring	7
- Plate anchor	7
3.3/ Third generation: eco-designed mooring	8
- Eco-designed mooring	8
<b>4/ CONCLUSION</b>	<b>9</b>
<b>5/ SELECTED BIBLIOGRAPHY</b>	<b>10</b>
<b>6/ ANNEXE</b>	<b>11</b>
6.1/ 1st example Indian Ocean, Mayotte: eco-designed pipeline in coral reef ecosystem, in 2009	11
6.1/ 2nd example Caribbean Sea, Deshaies: eco-designed mooring in coral reef ecosystem, in 2014	15

Pioch, S., Léocadie, A. (2017). Overview on Eco-moorings facilities: Commented bibliography. International Coral Reef Initiative (ICRI), Foundation for the Research on Biodiversity (FRB) report.



This commented bibliography aims to present different types of eco-moorings that are referenced in scientific and selected publications.

Eco-moorings are permanent moorings that have no impact on nearby ecosystems. Eco-designed moorings, also propose a level of support for marine ecosystems, such as coral reef or fauna and flora (see "Eco-designed mooring" factsheet).

## 1/ HISTORICAL

Coastal marine ecosystems are exposed to an increasing number of pressures: urbanization, soil erosion, eutrophication, and domestic or chemical pollution (Maragos, Crosby et Mcmanus, 1996; Roussel et al., 2010). Other problems can occur on a smaller scale: for example, the anchoring associated with yachting and boating activities have a negative impact upon coral and seagrass (Milazzo et al. 2002). The consequences of anchoring are widespread and for conventional mooring are localized and permanent. The popularity of blue tourism and yachting activities generates positive economic development for local communities (Widmer and Underwood 2004; Sidman and Fik 2005). Of course, the impacts of mooring are proportional to the number of boats in the area, and its attractiveness: the more popular the environment, the more damage to the seabed caused. Diving and recreational activities, including coral reef exploration are the most popular activities, especially in tropical areas (Venturino et al., 2015).

Management programs attempt to reduce this kind of impact (Gray et al., 2010, Balaguer et al., 2011). Strategies have been adopted in order to reduce the number of boats, limit moorings during certain periods and limit moorings deployment (Milazzo et al., 2002; La Manna et al., 2015). But these strategies alone cannot answer to the growing demand of yachting and boating in coral reef areas. To encompass with economic and ecological objectives, since the 1990's, several facilities were developed in the field of "eco-mooring".

# 2/ ANCHORING ISSUES

The negative impacts of anchoring on the seabed can be separated into two categories.

## 2.1/ IMPACT OF ANCHORING

The impact of anchoring is characterized by the destruction of habitats when the anchor is dragging on the bottom of the sea bed (Jackson et al., 2013). Moreover, the degree of impact can depend upon the type of anchor. For example, a grapnel anchor causes the most damage to seagrass within coral ecosystems (Milazzo et al., 2004). Coral reef ecosystems are very exposed (Giglio et al., 2017), as demonstrated in Fig 1.

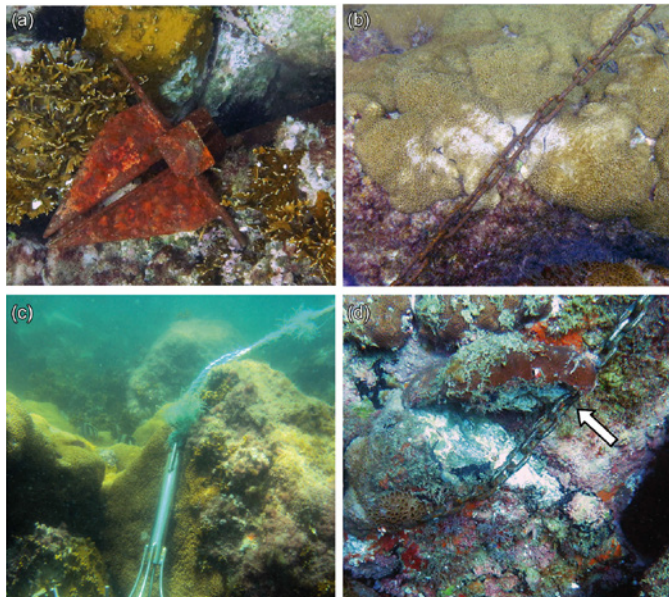

Figure 1: anchoring impact of coral reef a) and b) *m. alcornicis* c) and d) *p. caribaeorum* (giglio et al., 2017)

## 2.2/ IMPACT OF CONVENTIONAL MOORING

The impacts of conventional mooring consist of chains that scrub on the substrate, destroying the immediate environment (see Fig. 2 from Demers et al., 2013). Walker et al. (1989) already indicated the effects of conventional mooring. It can make crop circles as large as 3 to 300m<sup>2</sup> in the area of mooring. West in 2012, suggests that this damage can be observed on Google Earth (see Fig 3.).

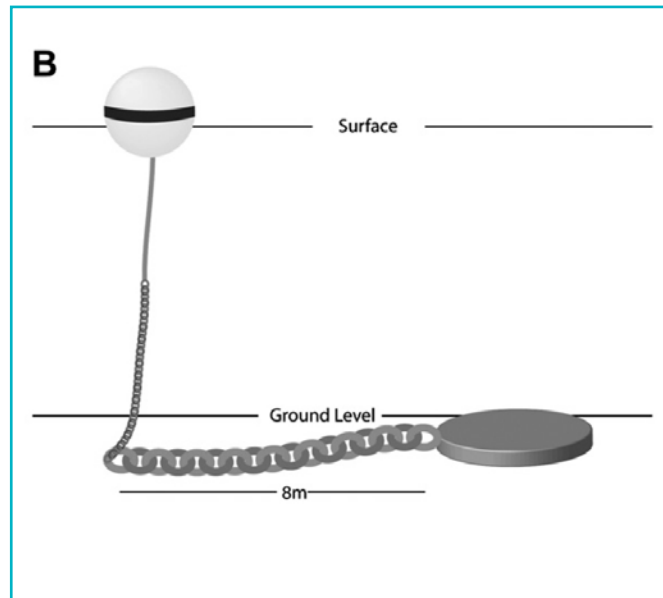

Figure 2: schematic representation of conventional mooring: anchor chain dragging on the ground level with a circular negative impact on the ecosystem (demers et al., 2013)

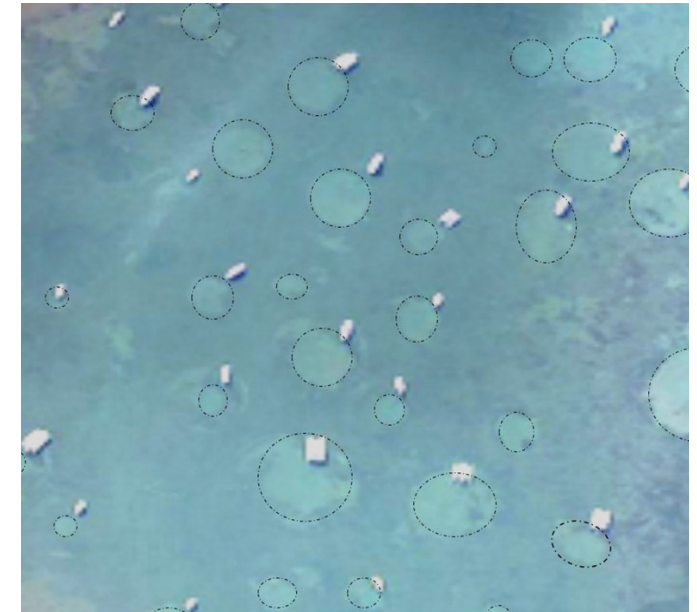

Figure 3: crop circles (dotted line) in moreton bay (australia), due to chain dragging from bad mooring system on the sea ground,-destroying seagrasses within coral reef ecosystem (© seq catchments)

In Moreton bay (Brisbane, Australia), in 2010, the negative impact of bad mooring system on coral reef ecosystem sea-floor (seagrasses) was around 15%. On Figure 3, for 20 000 m<sup>2</sup> of seafloor, 3 900 m<sup>2</sup> were destroyed. The amount of disturbance varies with the length of the mooring chain and may be up to 1 400 m<sup>2</sup> per vessel in Moreton Bay.

# 3/ THREE GENERATIONS OF ECO-MOORINGS

The difference between eco-mooring (coral reef or seagrass friendly mooring) and conventional moorings (as well as direct boat anchoring without any pre-disposed system), is that the anchor line (chain or rope) does not dredge the sea floor. Three generations of eco-mooring have been developed.

## 3.1/ FIRST GENERATION: PRE-TENSED ANCHOR LINE MOORING SYSTEMS

The first generation of eco-mooring can be characterized by a simple concrete block on the seafloor as the mooring system, topped with a pre-tensed anchor line.

### Concrete block mooring

The concrete block mooring is simply at-tached by a pre-tensed chain (or a rope) to the floating buoy (fig 4.) (Francour et al., 2006). To limit the impact on coral reef sea-ground, the location of the block has to be assessed before.

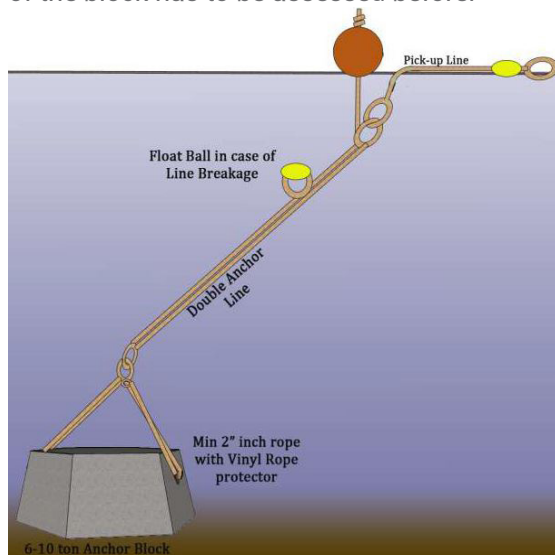

Figure 4: schema of conventional block fitted with pre-tensed anchor line, on the mooring line buoy (master-divers.com)

### Eco-mooring using artificial reef as anchor block

The first design phase of construction is focused on creating an artificial reef system that encourages the development of fauna and flora. This artificial reef block is then connected with a pre-tensed anchor line (see Fig 5). This mooring is similar to eco-designed mooring (see part 3), but in this case, the anchor system is not fitted for boating purposes and holds constraints of stability, weight (effort on the rope and chain, attached to the boat), hydrodynamic effect (scouring, movement) and concrete durability.



Figure 6 : eco-mooring using artificial reef as anchor block (reef life restoration@)

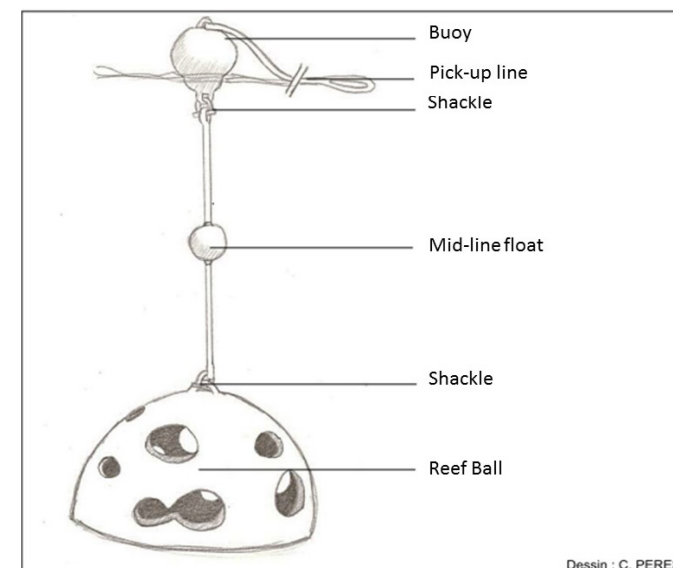

Figure 5: artificial reef with mooring system (reefball ©)

## 3.2 / SECOND GENERATION: SCREW AND FIXED ANCHOR LINE

The second generation of eco-mooring is a screw, and all other kind of systems that helps to fix the anchor line directly to the seabed. It was created to reduce at maximum impact of anchoring fixation, by minimizing the surface in contact with the substrate.

### Cyclone

This is one of the oldest in the second-generation mooring techniques (Demers et al., 2013) It uses three prongs that point in three directions, which minimizes contact with the seabed (Mc Kiernan, 2011) (Fig.7). The Cyclone system is found in Callala Bay (Australia). An example of cyclone mooring is seen in the Ezyrider Offset Anchor System © (Fig.8).

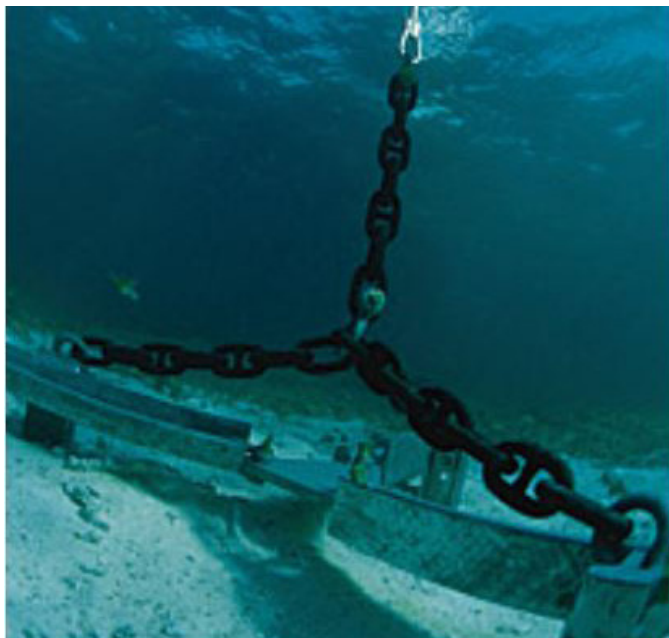

Figure 8: Example of Ezyrider Offset Anchor System © (tradeonlytoday.com)

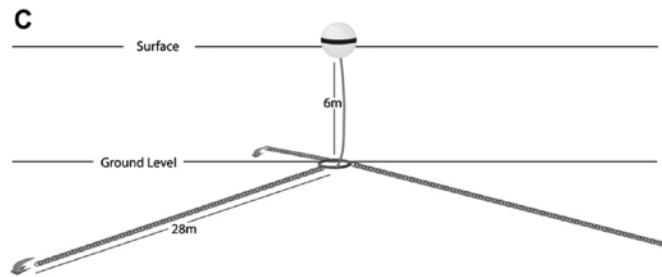

Figure 7: schema cyclone mooring (Demers et al., 2013)

As stated by Demers et al., (2013), Cyclone mooring can present dramatic damages, beyond the effects of conventional mooring. Indeed, large areas cleared of seagrass can be observed, generally up to 18 m from the center of each mooring. Demers & al. (2013), show that Cyclone efficiency declines over time. Regular maintenance of these moorings and the monitoring of surrounding seagrass is required to en-sure that 'seagrass-friendly' moorings are operating effectively.

### Helical mooring

Helical anchors are used for soft coral ecosystem substrate. The pre-tensioned chain is directly fixed on the seafloor with a screw (see Fig. 9). Two alternatives can be considered:

#### Harmony anchor

This anchor is a special corkscrew (Fig. 9-A). The anchor is simple, reliable and resistant. This system can be used especially in seagrass meadows, or soft bottom area within coral reef ecosystems (Francour et al., 2006). According to Francour et al. (2006), the ecological impact is "close to zero".

#### Screw type

This anchor is a double helical disc (Fig.9-B). Generally, it is used on sand or mud (Francour et al., 2006). Like the "Harmony" eco-mooring system, the negative ecological impact should be considered as negligible (Demers, 2012). According to PADI (1996), the first helical screw anchor prototype was patented in the 1800's. It was made to support lighthouses in the Chesapeake Bay (USA). Now this anchor is employed in several countries: Florida (USA), Australia as well as French and English overseas Territories

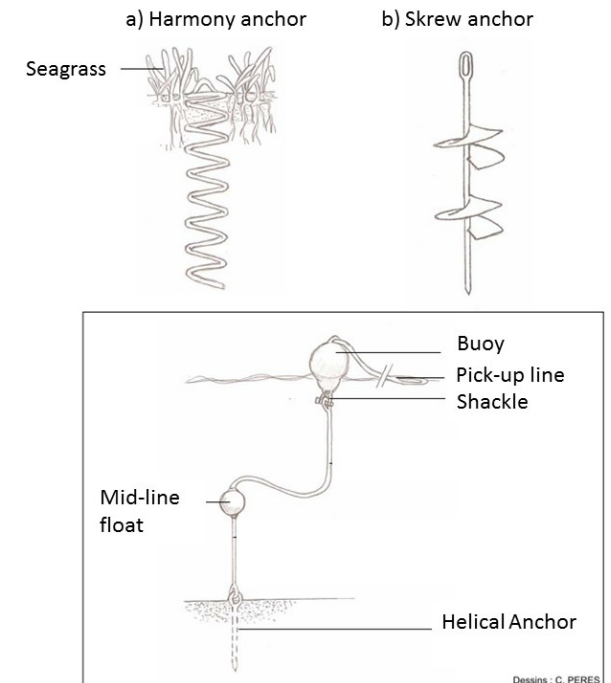

Figure 9: schema of helical anchor a) "Harmony" type b) "Skrew" type c) Global schematization (OMMM, 2006)

## Fixed eco-mooring

Other examples, directly fixed with different techniques in the seafloor.

### Eye Bolt system

Eye bolt system (also named "Halas mooring system") is a stainless-steel eyebolt cemented into a hole drilled into the sea floor (PADI, 2006) (see Fig. 10 left).

### Manta Ray

This mooring system is a steel rod with a swivel head, used on mixed sea floors (coral, clays, sand, gravel, etc.). The first Manta ray system was installed in Florida's Key Largo National Marine Sanctuary (see fig. 10 right).

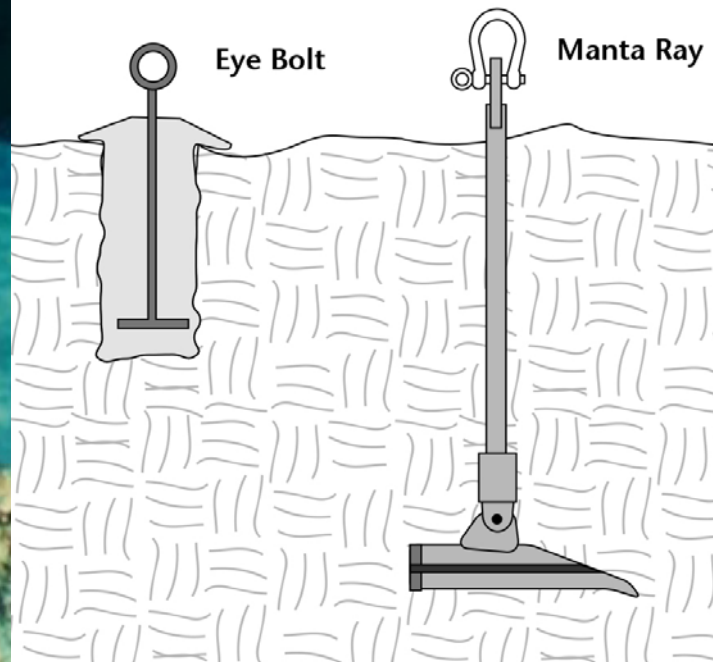

Figure 10: fixed eco-mooring two pictures left eye bolt and right manta ray (padi, 1996; reef relief founders)

## Plate anchor

This system is a plate and an anchor ring sealed onto coral reef rocks. It is adapted to coral rocky substrates (Francour et al., 2006) (Fig. 11).

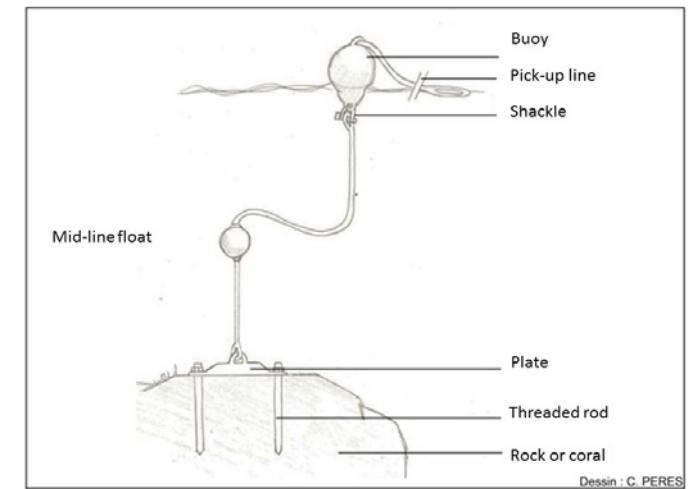

Figure 11: Schema grouted anchor system (OMMM, 2006)

### 3.3 / THIRD GENERATION: ECO-DESIGNED MOORING

The third generation of eco-mooring consist of a mooring block designed with ecological considerations (Pioch et al., 2011). In Annex, see 2 examples developed in a Port-folio.

#### Eco-designed mooring

It is an eco-engineering approach, where the mooring design is aimed to be aligned with the purpose of enhancing coral reef fauna and flora (Fig. 12). The two main objectives are:

- A real mooring buoy program to prevent any future damage to corals from anchoring.
- A unique coral reproduction technique that helps to restore damage from the concrete blocks that were previously used for mooring.



Figure 12: Colonization of an eco-de-signed mooring system 2 years after immersion (Pioch)

The idea of “building with nature” has been developed in order to associate effective mooring concrete blocks with:

- Biomimicry of local habitats (cavities, roughness, etc.) through an eco-designed anchor.
- Taking advantage of these hard and protected substrates to restore and accelerate the restoration of coral reef ecosystems that have been destroyed by past «unorganized anchorages».

This type of mooring allows an acceleration of recolonization, thus associating an engineering project with an ecological restoration project. Eco-designed moorings are designed for each specific context, considering hydrodynamics, yacht size (block weight), as well as local biodiversity.

It is not a system that can be identically replicated for all situations. Individual cases of local habitat mimicking, endangered species, and functional targets have to be specified to guide the design of the concrete blocks, in order to achieve optimum ecological performance (Fig. 13).

From a technical aspect, the material durability, stability and the mooring system itself has to be adapted to the boat size and the hydrodynamic parameters. Finally, aesthetic considerations for landscape integration have to be developed. Eco-design mooring was installed in Deshaies (Guadeloupe, French Caribbean sea) or Mamoudzou (Mayotte, French Indian Ocean) (Fig. 14).

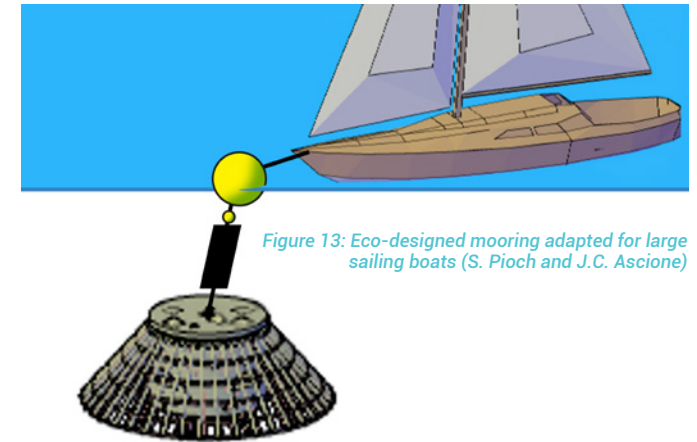

Figure 13: Eco-designed mooring adapted for large sailing boats (S. Pioch and J.C. Ascione)

After the tremendous Irma hurricane in Caribbean islands in 2017, all the eco-designed mooring devices submerged in Deshaies (Guadeloupe, French overseas), were safe and operational. This confirms that eco-designed mooring can be durably fitted both for technical and ecological purposes.



Figure 14: Coral development on an eco-designed mooring support, three years after immersion in des-haies (photo Delavigne)



## 4/ CONCLUSION

Although these three generations of eco-moorings have been developed since the 1990's, very few long term ecological surveys have been made (Egerton, 2011). However, Collins et al. (2010) has shown that seafloor restoration, after eco-friendly mooring installation, is not easy and may take years. The concept of eco-design has to be recommended not only for mooring facilities, but for all coastal infrastructures: harbor, jetty, breakwater and sewage outfall. The objective is not to increase coastal artificialization, nor to justify future constructions, but to take advantage of all the supports immersed to develop new habitats for coral fauna and flora. Thus, more widely, eco-designed coastal infrastructures are facilities designed with both socio-economic and ecological considerations (Pioch et al., 2011) see fig. 15, for the concept.

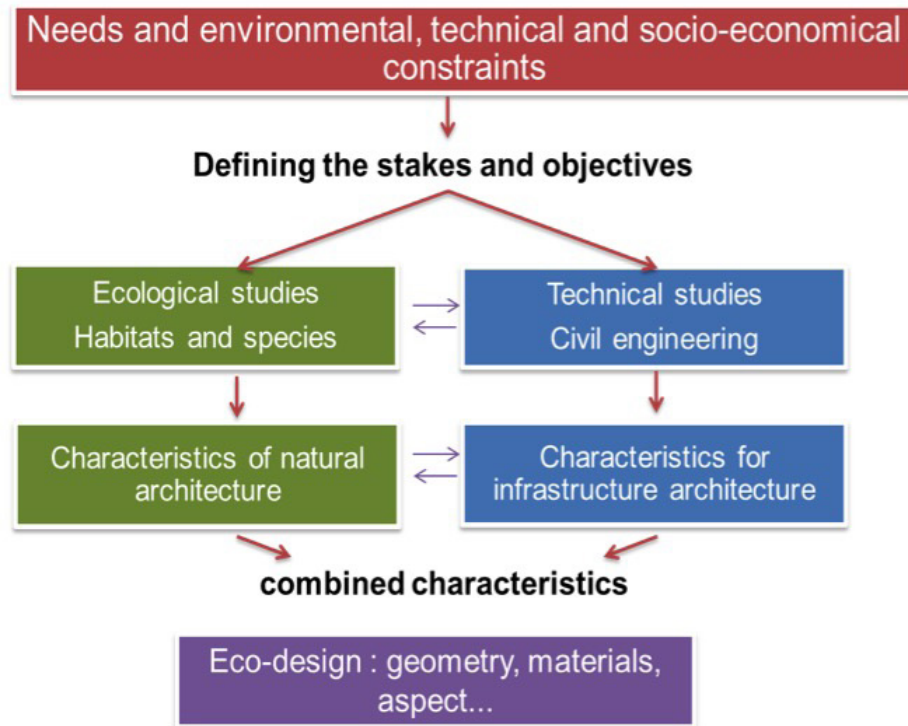

Figure 15: eco-design coastal infrastructure, a conceptual approach (Pioch)

**Within the “working with nature” a new engineering approach.** It requires a subtle but important evolution in the way we approach new projects. We need to move towards an approach that focuses on:

- Achieving the project objectives **in an ecosystem context** rather than assessing the consequences of a predefined project design;
- Identifying **win-win solutions rather than minimizing ecological impact**, by develop-ing biodiversity support during the early design phases of infrastructure.

(World Association for Waterborne Transport Infrastructure, 2011).

The roughness, the habitat deployment (refuge, hole...) and the concrete formula of eco-designed in-frastructures are specifically adapted to enhance the colonization (see photos in following figures) and the durability for the better socio-economic, as well as, ecological developments.

***This new engineering approach have to be especially recommended in coral reef ecosystem, exposed to many pressures.***

We recommend the eco-mooring systems as an approach for all coastal infrastructure projects, in order to decrease their negative ecological impacts and improve their ecological integration.

## 4.1 / SELECTED BIBLIOGRAPHY

**Balaguer, P., Diedrich, A., Sardá, R., Fuster, M., Cañellas, B., & Tintoré, J.** (2011). Spatial analysis of recreational boating as a first key step for marine spatial planning in Mallorca (Balearic Islands, Spain). *Ocean & coastal management*.

**Collins, K., Suonpaa, A. & Mallinson, J.** (2010). The impacts of anchoring and mooring in seagrass, Studland Bay, Dorset, UK. *International Journal of the Society for Underwater Technology*.

**Demers, M. C. A., Davis, A. R., & Knott, N. A.** (2013). A comparison of the impact of 'seagrass-friendly' boat mooring systems on *Posidonia australis*. *Marine environmental research*.

**Egerton., J.** (2011). Management of the seagrass bed at Porth Dinllaen. Initial investigation into the use of alternative mooring systems. Report for Gwynedd Council.

**Francour P., Magréau J.F., Mannoni P.A., Cottalorda J.M., Gratiot J.** (2006). Ancrages écologiques permanents. Guide d'Aide à la Gestion des Aires Marines Protégées. Université de Nice-Sophia Antipolis et Parc National de Port-Cros, Nice.

**Jackson, E. L., Griffiths, C. A., Durkin, O.** (2013). A guide to assessing and managing anthropogenic impact on marine angiosperm habitat-Part 1: Literature review. Natural England Commissioned Reports.

**La Manna, G., Donno, Y., Sarà, G., Ceccherelli, G.** (2015). The detrimental consequences for seagrass of ineffective marine park management related to boat anchoring. *Marine pollution bulletin*.

**Giglio, V. J., Ternes, M. L., Mendes, T. C., Cordeiro, C. A., Ferreira, C. E.** (2017). Anchoring damages to benthic organisms in a subtropical scuba dive hotspot. *Journal of Coastal Conservation*.

**Gray, D. L., Canessa, R., Rollins, R., Keller, C. P., Dearden, P.** (2010). Incorporating recreational users into marine protected area planning: a study of recreational boating in British Columbia, Canada. *Environmental management*.

**Maragos, J. E., Crosby, M. P., Mcmanus, J. W.** (1996). Coral reefs and biodiversity: a critical and threatened relationship. *Oceanography*.

**Milazzo, M., Chemello, R., Badalamenti, F., Camarda, R., Riggio, S.** (2002). The impact of human recreational activities in marine protected areas: what lessons should be learnt in the Mediterranean sea? *Marine ecology*.

**Milazzo, M., Badalamenti, F., Ceccherelli, G., Chemello, R.** (2004). Boat anchoring on *Posidonia oceanica* beds in a marine protected area (Italy, western Mediterranean): effect of anchor types in different anchoring stages. *Journal of Experimental Marine Biology and Ecology*

**Observatoire du Milieu Marin Martiniquais (OMMM),** (2006). Synthèse des types de corps-morts permanents pour le mouillage des bateaux de plongée sur les côtes de Martinique. Dir. Péres C., Observatoire Eau Martinique.

**PADI,** (1996). Mooring Buoy Planning Guide. PADI Aware, Rancho Santa Margarita.

**Pioch, S., Kilfoyle, K., Levrel, H., Spieler, R.** (2011). Green marine construction. *Journal of Coastal Research*.

**Roussel E., Gabrie C., Duncombe M.** (2010). Les mangroves de l'Outre-mer français. Conservatoire du littoral.

**SEQ Catchments,** consulted November 14th on: <http://www.seqcatchments.com.au>

**Sidman, C. F., Fik, T. J.** (2005). Modeling spatial patterns of recreational boaters: vessel, behavioral, and geographic considerations. *Leisure Sciences*.

**Venturini, S., Massa, F., Castellano, M., Costa, S., Lavarello, I., Olivari, E., Povero, P.** (2016). Recreational Boating in Ligurian Marine Protected Areas (Italy) : A Quantitative Evaluation for a Sustainable Management. *Environmental management*.

**West, R.** (2012). Impacts of recreational boating activities on the seagrass *Posidonia* in SE Australia. *Wetlands Australia Journal*.

# 5/ ANNEXE

## 5.1/ 1<sup>ST</sup> EXAMPLE INDIAN OCEAN, MAYOTTE: ECO-DESIGNED PIPELINE IN CORAL REEF ECOSYSTEM, IN 2009



Mayotte, french overseas, one of the greater lagoon in the world (© google map)

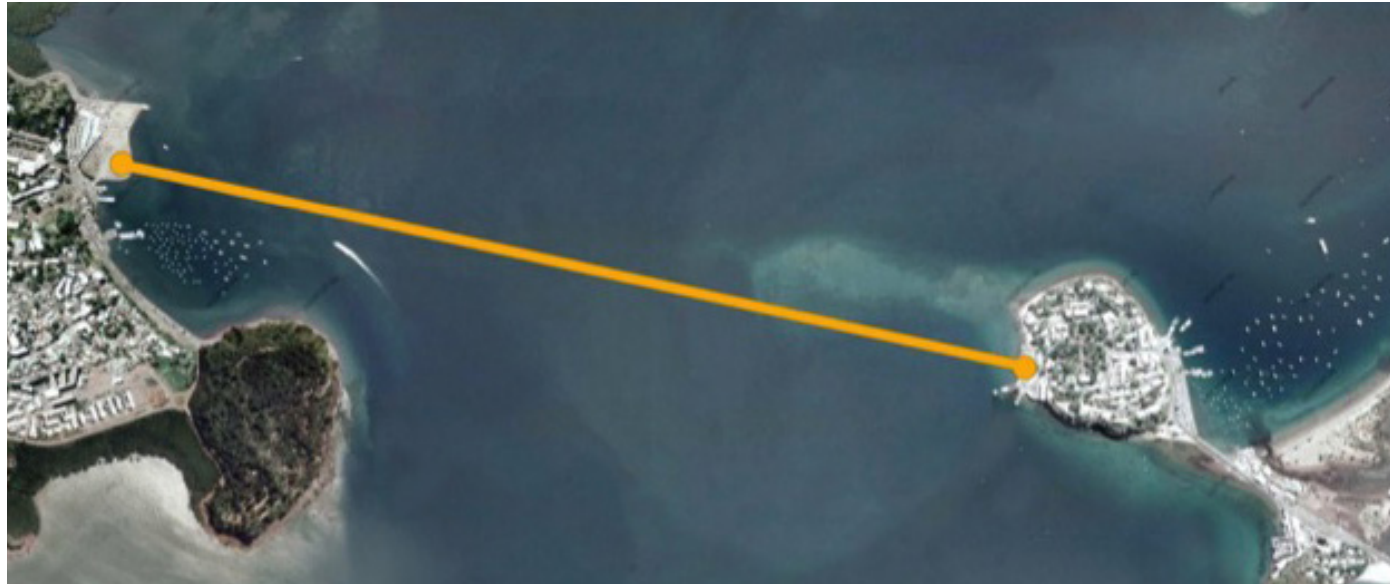

The project is a 2.5 Km pipe of fresh water in coral seafloor (© Google Maps)

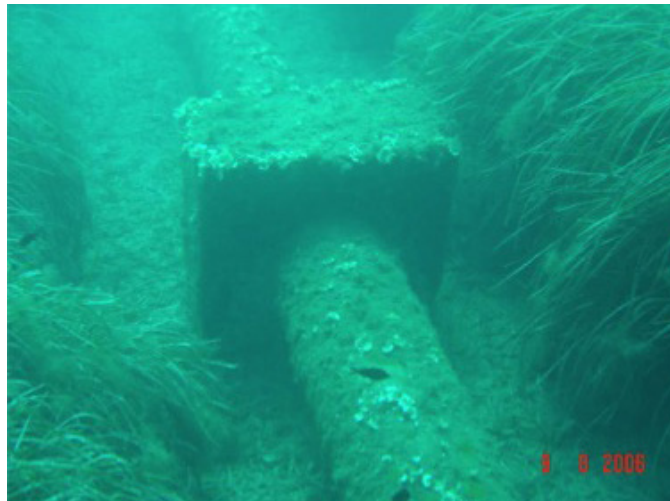
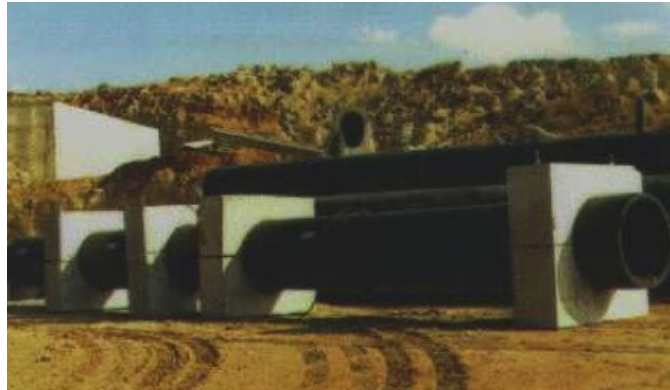
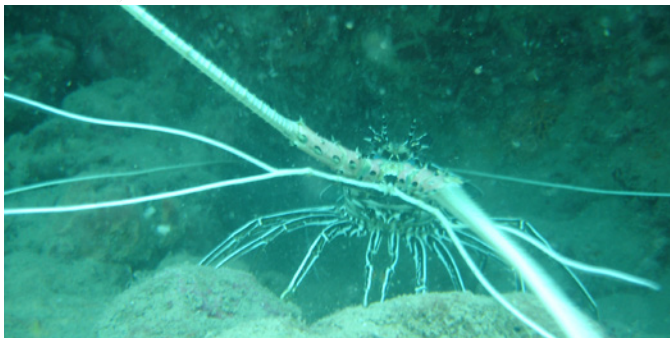
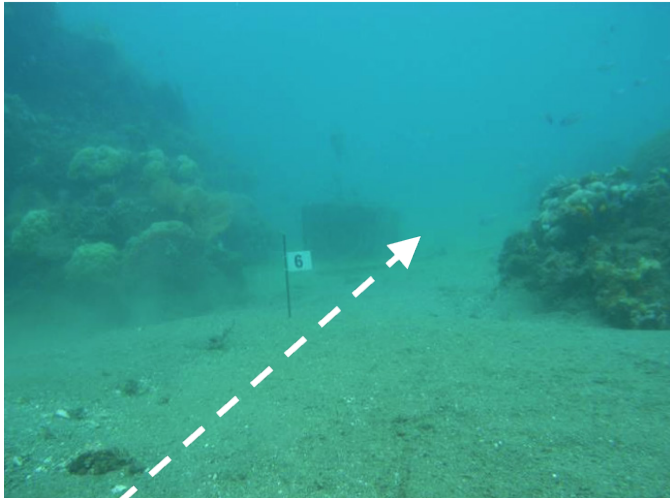
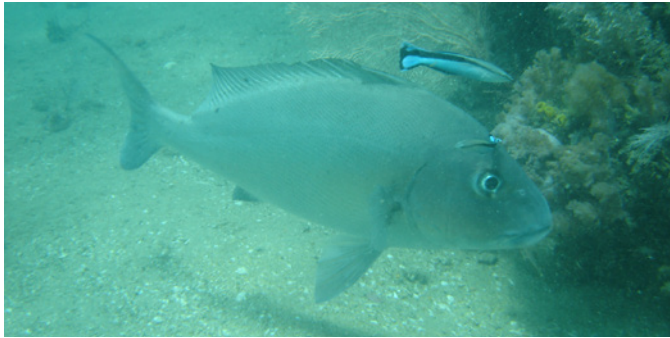

Traditional solutions to maintain the pipe against the sea movements (concrete blocks) with no ecological consideration in their design (Egis)

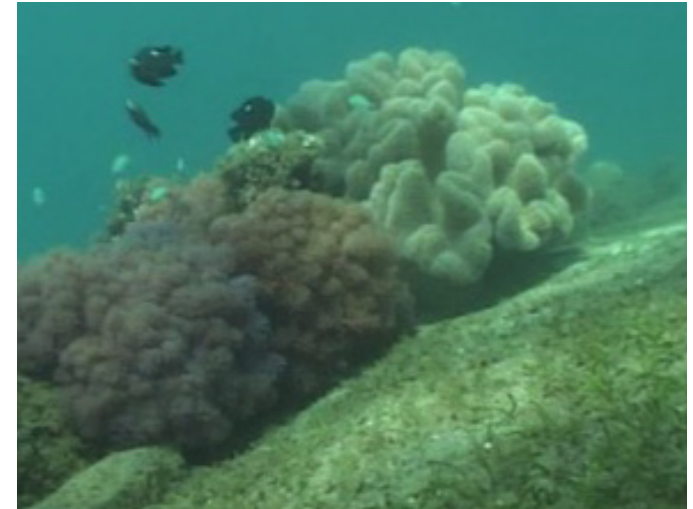

Diversified fauna and flora on the track of the pipe (Saussol & Bigot)

Great and remarkable coral formations all along the layout of the pipe (avoid direct destruction, see white arrow "slaloming" between coral area)

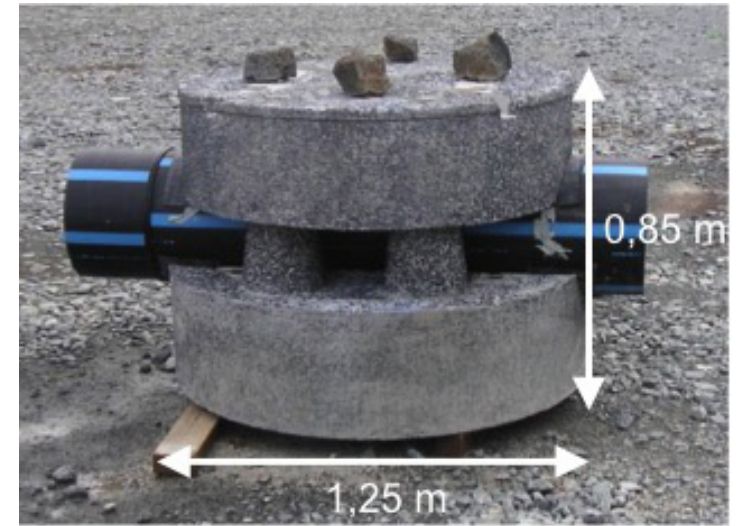
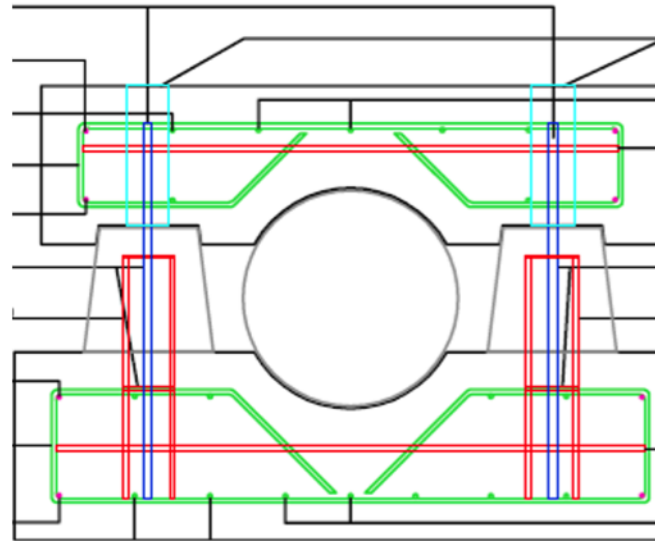
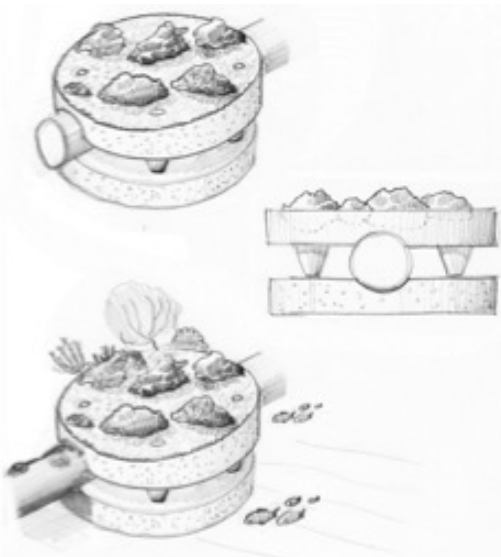

First drawing (left) and final design (center) tested with a prototype (right) (Piocch & Feron, with courtesy of Egis eau)



Construction and installation of eco-designed pipe-line in 2009 (Cadet)

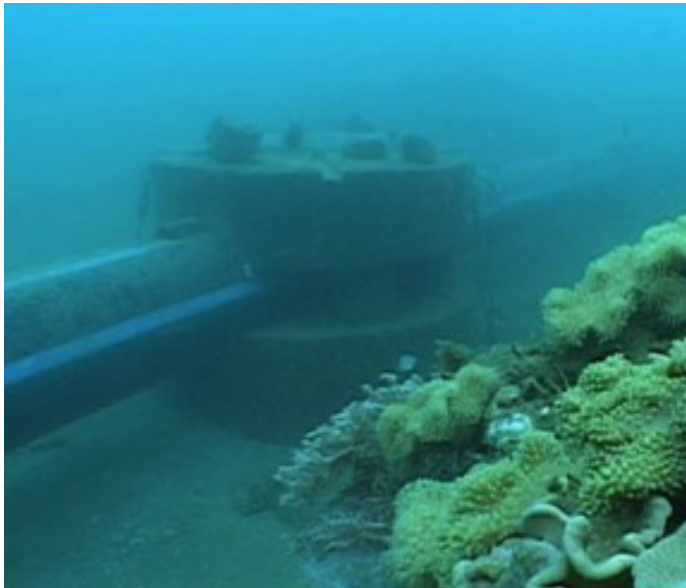
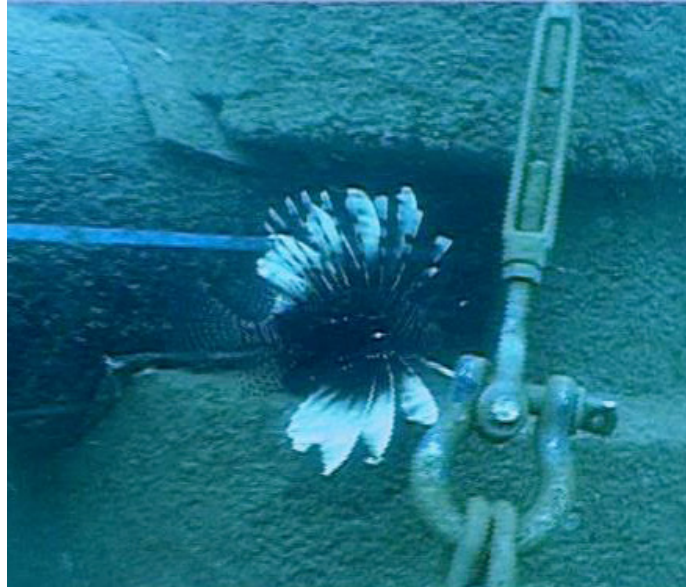
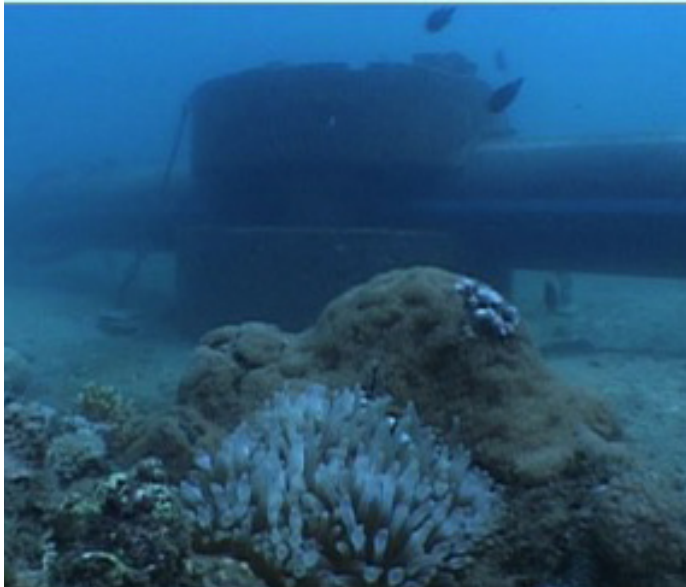

*After 1 month of immersion (Bigot)*



*The eco-designed pipe-line after 8 years, in 2017 with coral ecosystem development (Iagonia)*

## 5.2/ 2<sup>ND</sup> EXAMPLE CARIBBEAN SEA, DESHAIES: ECO-DESIGNED MOORING IN CORAL REEF ECOSYSTEM, IN 2014

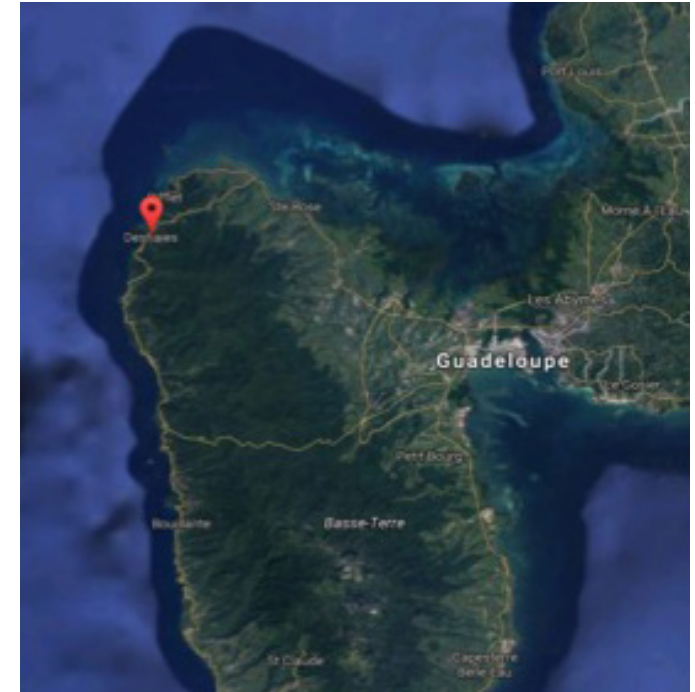
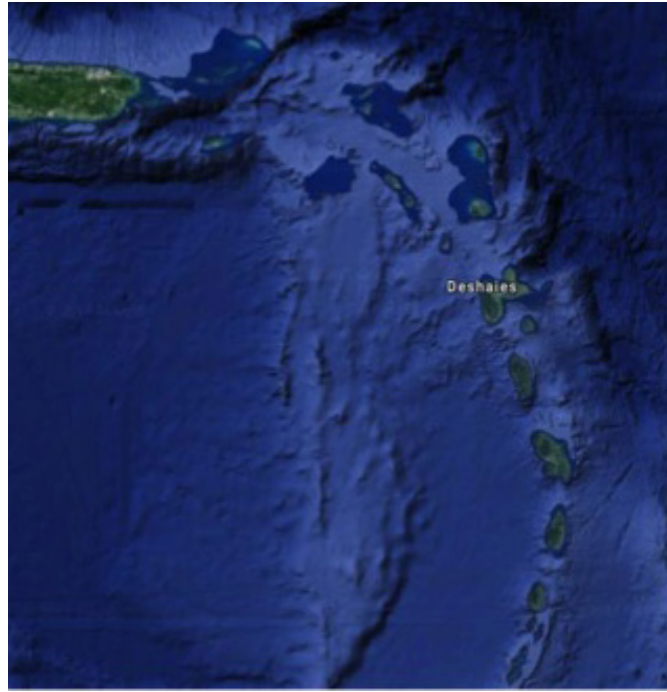

*Deshaies in Guadeloupe, French Overseas (© Google Maps)*



*Boating And Anchoring Effect (Chain Dragging On The Bottom Left And Circle Crop Right) In The Deshaies Bay (Piach)*



*Coral reef degradation due to anchoring and tire as old mooring block (Piach)*



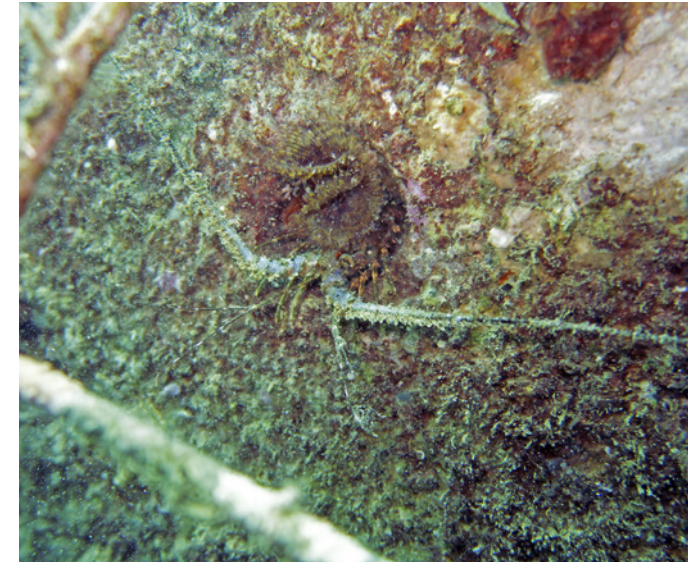
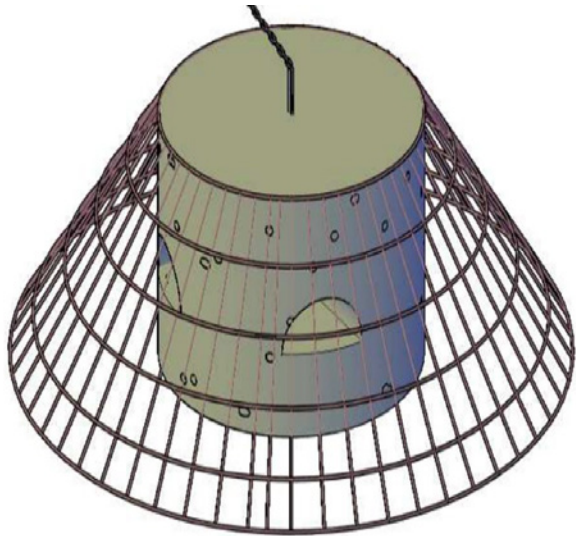

Juvenile of lobster installed in an effective designed habitat (see the hole in figure before) (Bouchon & Delavigne)



Example of one of the 4 types of eco-designed mooring with specific concrete to enhance coral ecosystem development (Pioch, Sogetras & Ascione)



Specific disposal for coral fixing on rocks and habitat for lobster juveniles (Hole)



*Fish juveniles and corals on and in habitats developed on an eco-designed mooring after 3 years, in 2017 (Bouchon)*



## INTERNATIONAL CORAL REEF INITIATIVE (ICRI)

The International Coral Reef Initiative (ICRI) is an informal partnership between Nations and organizations which strives to preserve coral reefs and related ecosystems around the world.

Although the Initiative is an informal group whose decisions are not binding on its members, its actions have been pivotal in continuing to highlight globally the importance of coral reefs and related ecosystems to environmental sustainability, food security and social and cultural wellbeing. The work of ICRI is regularly acknowledged in United Nations documents, highlighting the Initiative's important cooperation, collaboration and advocacy role within the international arena. ICRI's objectives are to:

- Encourage the adoption of best practice in sustainable management of coral reefs and associated ecosystems
- Build capacity
- Raise awareness at all levels on the plight of coral reefs around the world.

ICRI was created in 1994 by 8 countries (France, the United States of America, Australia, the United Kingdom, Japan, Jamaica, Philippines and Sweden), and announced on the occasion of the first Conference of the Convention of Parties on biological diversity in 1994. Today, it gathers 37 countries and nearly 80 members in total.

For further information: [www.icriforum.org](http://www.icriforum.org)

*This document was produced to address goal 3.4: promote the deployment of mooring devices limiting the mechanical destruction of coral reefs and seagrasses of the ICRI plan of action 2016/2018 developed by the French government.*



« IN PARTNERSHIP WITH THE FRB »

## THE FOUNDATION FOR RESEARCH ON BIODIVERSITY (FRB)

promotes research to preserve, enhance and sustainably use biodiversity. The FRB was created in 2008 by eight public research institutions following the 'Grenelle de l'environnement'; an initiative of the ministries of research and ecology. The eight institutions have since been joined by LVMH, INERIS and the University of Montpellier.

The originality of the FRB lies within its role as an interface between the scientific community, civil society and the business world.

To date, more than 235 associations, companies, managers and local communities have collaborated with the FRB to meet its goal: meeting the scientific challenges of biodiversity.

The FRB collaborates with the International Coral Reef Initiative (ICRI) to implement of the 2016-2018 ICRI action plan with the aim to transfer knowledge about marine biodiversity.

More informations:

<http://www.fondationbiodiversite.fr/en/>

*Funded with the support of the government of sweden in partnership with the FRB*

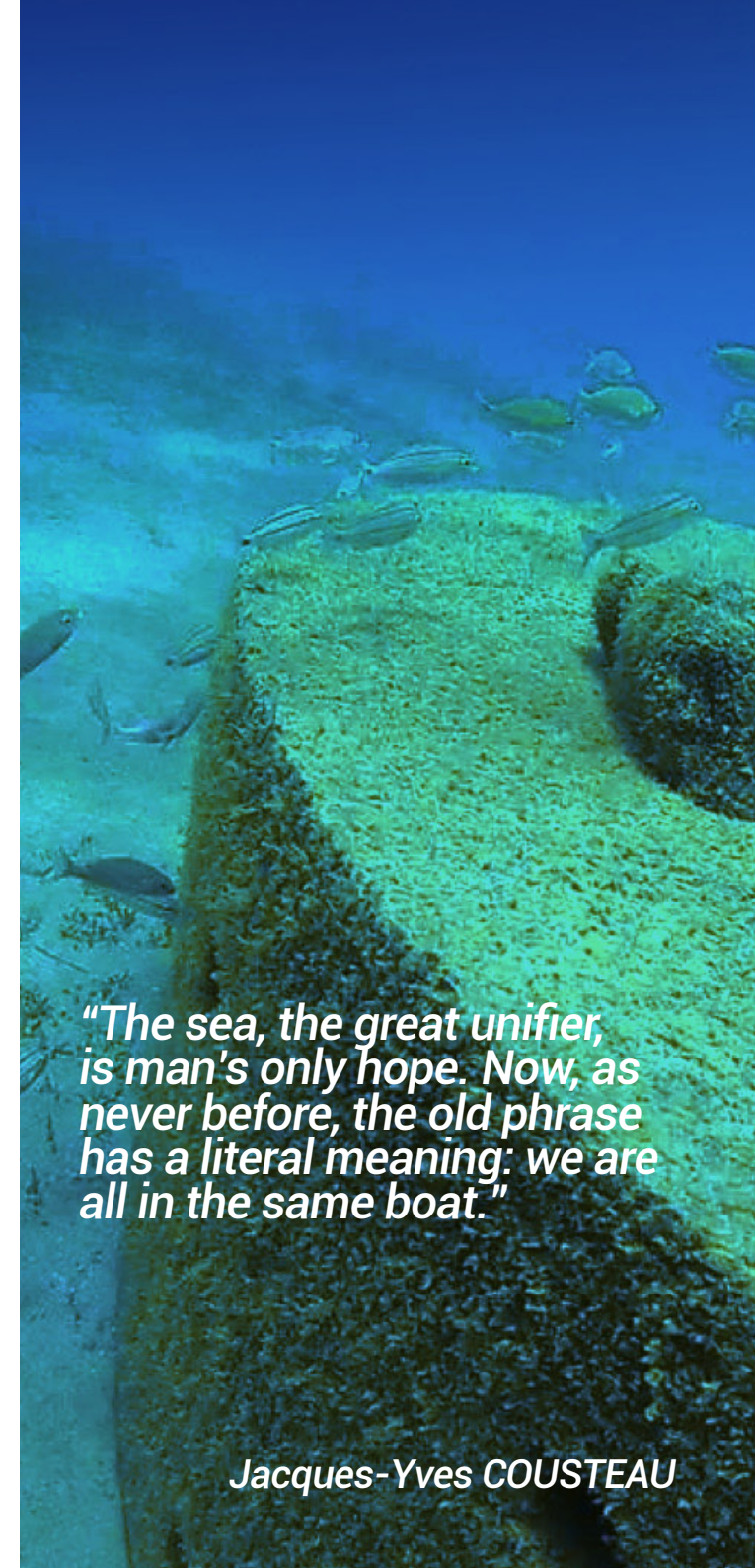

*“The sea, the great unifier, is man’s only hope. Now, as never before, the old phrase has a literal meaning: we are all in the same boat.”*

**Jacques-Yves COUSTEAU**